



**Techno India NJR Institute of Technology**  
**Academic Administration of Techno NJR Institute**  
**Syllabus Deployment**

**ELECTRONIC MEASUREMENT & INSTRUMENTATION LAB**

(4EC4-24)

**LAB MANUAL**  
**IV SEMESTER**

**Name: Rajkumar Soni**

**Subject Code: 4EC4-24**

**Lab Name: EMI Lab**

**SEM: IV**

**Department: Electrical Engineering**



# RAJASTHAN TECHNICAL UNIVERSITY, KOTA

## SYLLABUS

II Year - IV Semester: B.Tech. (Electronics & Communication Engineering)

### 4EC4-24: Electronics Measurement & Instrumentation Lab

Credit: 1.5

Max. Marks: 75(IA:45, ETE:30)

0L+0T+3P

List of Experiments	
Sr. No.	Name of Experiment
1.	Measure earth resistance using fall of potential method.
2.	Plot V-I characteristics & measure open circuit voltage & short circuit current of a solar panel.
3.	Measure unknown inductance capacitance resistance using following bridges (a) Anderson Bridge (b) Maxwell Bridge
4.	To measure unknown frequency & capacitance using Wein's bridge.
5.	Measurement of the distance with the help of ultrasonic transmitter & receiver.
6.	Measurement of displacement with the help of LVDT.
7.	Draw the characteristics of the following temperature transducers (a) RTD (Pt-100) (b) Thermistors.
8.	Draw the characteristics between temperature & voltage of a K type thermocouple
9.	Calibrate an ammeter using D.C. slide wire potentiometer
10.	Measurement of strain/force with the help of strain gauge load cell.
11.	Study the working of Q-meter and measure Q of coils.
12.	Calibrate a single-phase energy meter (Analog and Digital) by phantom loading at different power factor by: (i) Phase shifting transformer (ii) Auto transformer.

### Course Outcome:

Course Code	Course Name	Course Outcome	Details
4EC4-24	Electronic Measurement & Instrumentation Lab	CO 1	Understanding of the fundamentals of Electronic Instrumentation. Explain and identify measuring instruments.
		CO 2	Able to measure resistance, inductance and capacitance by various methods.
		CO 3	Design an instrumentation system that meets desired specifications and requirements.
		CO 4	Design and conduct experiments, interpret and analyze data, and report results.
		CO 5	Explain the principle of electrical transducers. Confidence to apply instrumentation solutions for given industrial applications.

Office of Dean Academic Affairs  
Rajasthan Technical University, Kota



# RAJASTHAN TECHNICAL UNIVERSITY, KOTA

## SYLLABUS

II Year - IV Semester: B.Tech. (Electronics & Communication Engineering)

### CO-PO Mapping:

Subject	Course Outcomes	PO 1	PO 2	PO 3	PO 4	PO 5	PO 6	PO 7	PO 8	PO 9	PO 10	PO 11	PO 12
4EC4-24 Electronic Measurement & Instrumentation Lab	CO 1	3	2	1	2	2	0	0	0	0	0	0	0
	CO 2	2	3	1	2	3	0	0	0	0	0	0	0
	CO 3	1	3	2	3	2	0	0	0	0	0	0	0
	CO 4	1	2	3	2	3	0	0	0	0	0	0	0
	CO 5	1	2	3	3	3	0	0	0	0	0	0	0

3: Strongly

2: Moderate

1: Weak

Office of Dean Academic Affairs  
Rajasthan Technical University, Kota

**LIST OF EXPERIMENTS**

<b>S.No.</b>	<b>NAME OF THE EXPERIMENT</b>	<b>PAGE No.</b>
1	TO STUDY BLOCKWISE CONSTRUCTION OF A ANALOG OSCILLOSCOPE & FUNCTION GENERATOR.	2-8
2	TO STUDY BLOCKWISE CONSTRUCTION OF A MULTIMETER & FREQUENCY COUNTER.	9-12
3	TO STUDY MEASUREMENT OF DIFFERENT COMPONENTS AND PARAMETERS LIKE Q OF A COIL USING LCR Q-METER.	13-16
4	TO STUDY DISTORTION FACTOR METER AND DETERMINATION OF THE % DISTORTION OF THE GIVEN OSCILLATOR.	17-19
5	TO DETERMINE OUTPUT CHARATERISTICS OF LVDT AND MEASURE DISPLACEMENT USING LVDT.	20-22
6	TO STUDY CHARACTERISTICS OF TEMPREATURE TRANSDUCER LIKE THERMOCOUPLE, THERMISTOR AND RTD WITH IMPLEMENTATION OF A SMALL PROJECT USING SIGNAL CONDITIONING CIRCUITS LIKE INSTRUMENTATION AMPLIFIER.	23-27
7	MEASUREMENT OF STRAIN USING STRAIN GAUGE.	28-30
8	TO STUDY DIFFERENTIAL PRESSURE TRANSDUCER & SIGNAL CONDITIONING OF OUTPUT SIGNAL.	31-33
9	MEASUREMENT OF LEVEL USING CAPACITIVE TRANSDUCER.	34-36
10	STUDY OF DISTANCE MEASUREMENT USING ULTRASONIC TRANSDUCER.	37-39

## EXPERIMENT No.1

**AIM:-** To study blockwise construction of Analog Oscilloscope & Function Generator.

### THEORY:-

#### CRO

The Cathode Ray Oscilloscope is probably the most versatile tool for deployment of electronic circuit and system. The CRO allow the amplitude of the electronic signals where they are voltage, current or power to be displayed as a function of time. The CRO depends on the moments of an electron beam which is being bombarded (impinged) on a screen coated with a fluorescent material to produce a visual spot. If the electron is being deflected along the conventional axes, i.e., x-axis & y-axis, two different displays are produced.

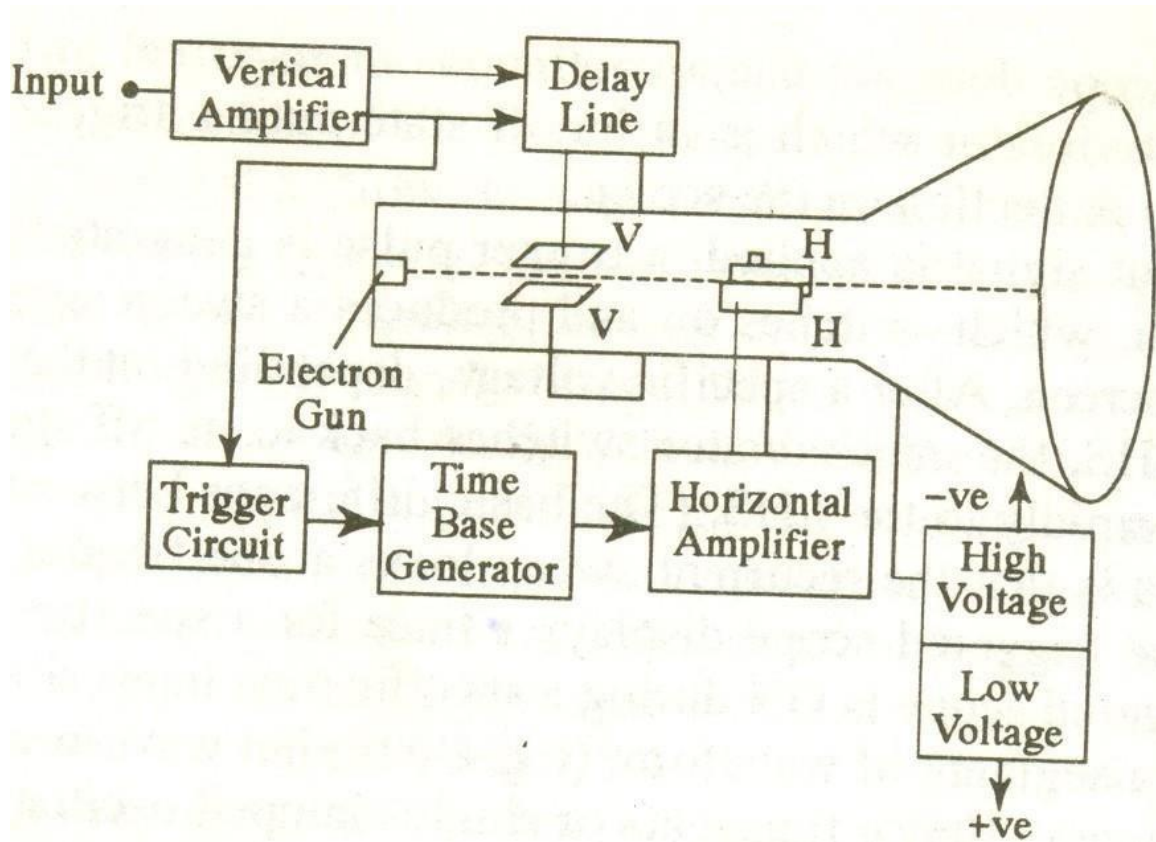

Fig:1 Block Diagram of CRO

#### Main parts of CRO-

**CRT:** - This is cathode ray tube in which electron beam strikes the screen internally to provide visual display of signal.

**VERTICAL AMPLIFIER:-** This is a wide band amplifier used to amplify signal in the vertical section of the signal.

**DELAY LINE:** – It is used to delay signal for sometime in the vertical section.

**TIME BASE:** – It is used to generate sawtooth voltage which it is applied to Horizontal deflection plates.

**HORIZONTAL AMPLIFIER:** - This is used to amplify the sawtooth voltage before it is applied to horizontal deflection plates.

**TRIGGER CIRCUIT:** - This is used to convert the incoming signal into trigger pulse so that the input signal and the sweep frequency can be synchronized.

**POWER SUPPLY:** – There are two power supplies, A negative high voltage (HV). supply and a +ve low voltage supply (LV). . The +ve voltage supply is from +300V to 400V, the negative voltage supply is from -1000V to -1500V.

### Front panel controls

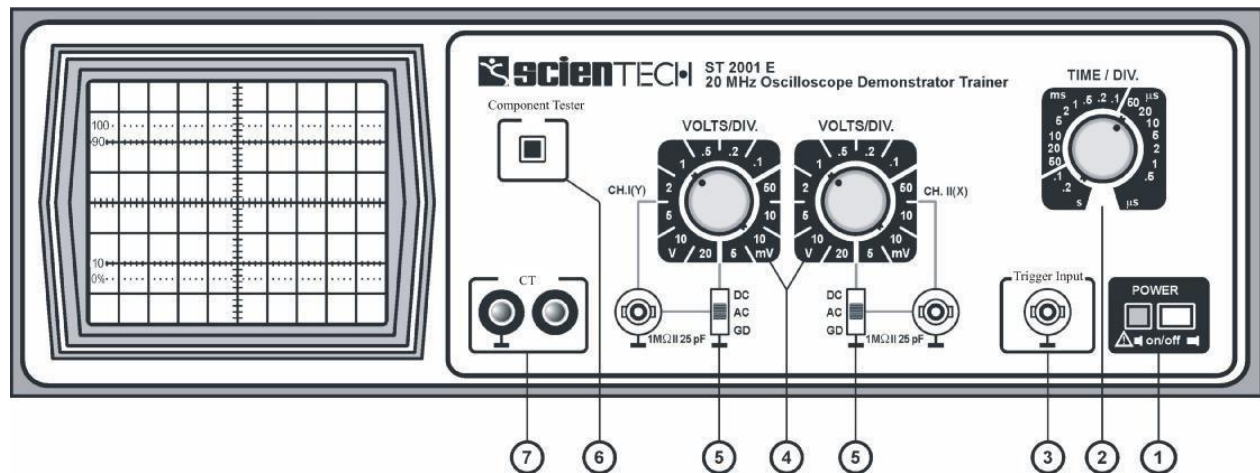

Fig:2 Front Panel of CRO

- (1) **Power 'On/Off':** Turns 'On' & 'Off'. LED indicates power 'On'. Use position & Int/Focus controls to get the beam. All are push buttons.
- (2) **Time / Div:** Rotary Switch for TB speed control.
- (3) **Trigger Input:** For feeding external trigger signal.
- (4) **Volts/Div:** For sensitivity selection of CH 1 & CH 2.
- (5) **DC-AC-Gnd:** Switch provided for Input coupling. BNC inputs provided for connecting the Input signal.
- (6) **Component Tester:** Switch when pressed converts scope into Component Tester mode.
- (7) **CT:** Input & Gnd terminals to be used for CT.

### Controls on PCB

- (1) **Intensity:** Controls the brightness
- (2) **Focus:** Controls the sharpness
- (3) **Trace Rotation:** Controls the horizontal alignment of the trace.
- (4) **X Pos:** Controls the horizontal position
- (5) **Y Pos I & II:** Controls vertical position of the trace.

## Electronic Measurement & Instrumentation (4EC4-24)

- (6) **XY** : When pressed cuts-off internal TB & connects external horizontal signal via. CH II
- (7) **X 5** : When pressed gives 5 times magnification.
- (8) **External** : When pressed allows ext. trigger.

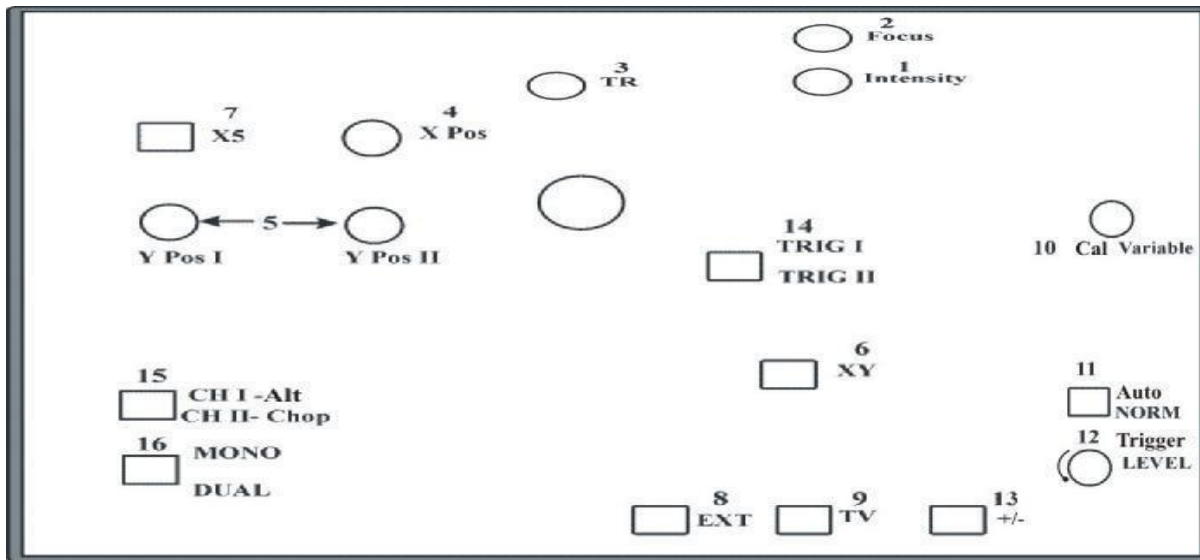

**Fig:3 Controls on PCB**

- (9) **TV** : When pressed allows TV frame to be synchronized.
- (10) **Cal Variable** : Controls the time speed in between the steps.
- (11) **Auto/ Norm** : In AT gives display of trace & auto trigger. When pressed becomes normal & gives variable level trigger.
- (12) **Level** : Controls the trigger level from positive peak to negative peak.
- (13) **+ / -** : Selects the slope of triggering.
- (14) **Trig 1/ Trig 2** : When out triggers CH I and when pressed triggers CH II
- (15) **CH I Alt/** : When out selects CH I and when pressed selects CH II. When dual switch also pressed this selects Alt or Chop modes.
- (16) **Mono / Dual** : When out, selects CH I only. When pressed selects both.

### Amplitude Measurements :

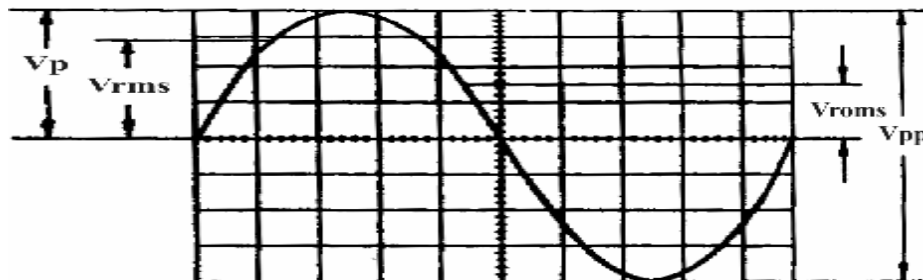

**Fig:4 Amplitude measurement using CRO**

$V_{rms}$  = effective value

$V_p$  = simple peak or crest value

$V_{pp}$  = peak-to-peak value

$V_{mom}$  = momentary value.

## Frequency measurement

$T$  = time in seconds for one period

$F$  = recurrence frequency in Hz of the signals,

$F = 1/T,$

$T_{tot} = 1.6 \text{ cm} \times 0.5 \text{ s/cm} : 5 = 160\text{ns}$

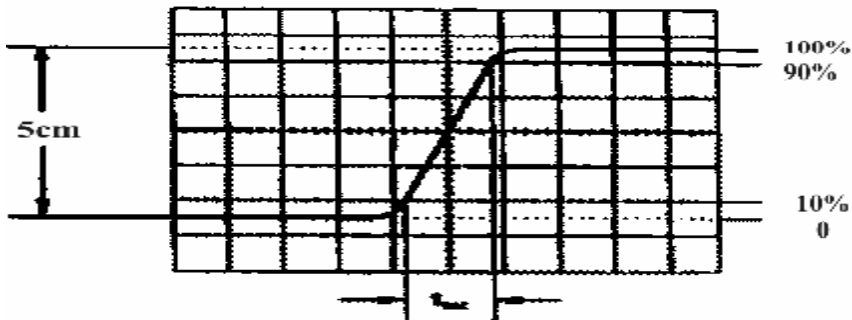

Fig:5 Frequency measurement using CRO

## Phase Measurement

$\sin q = a/b$

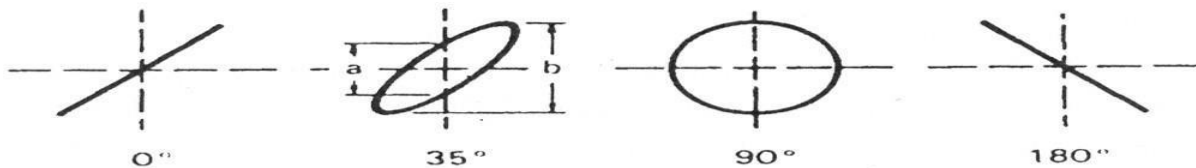

Fig:6 Phase measurement using CRO

## FUNCTION GENERATOR

### What is a function generator?

A function generator is a device that can produce various patterns of voltage at a variety of frequencies and amplitudes.



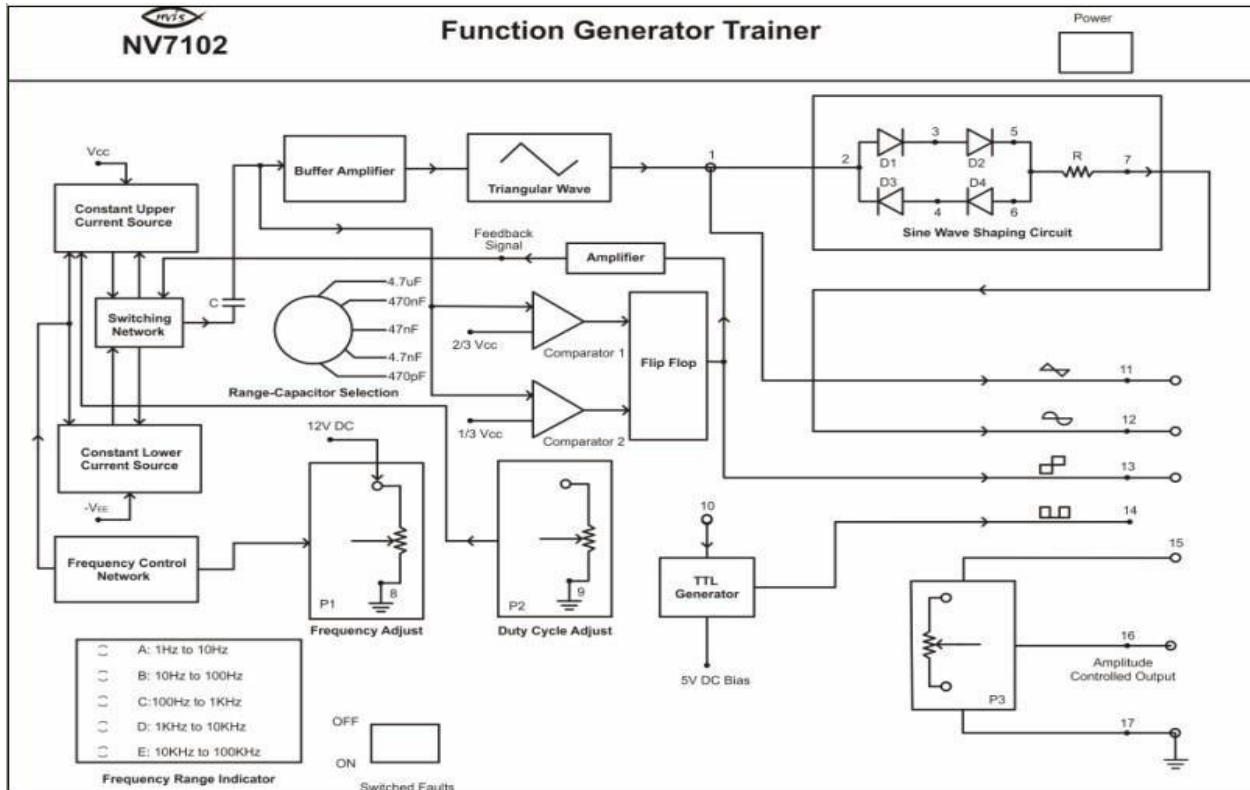

**Fig:7 Function generator circuit diagram**

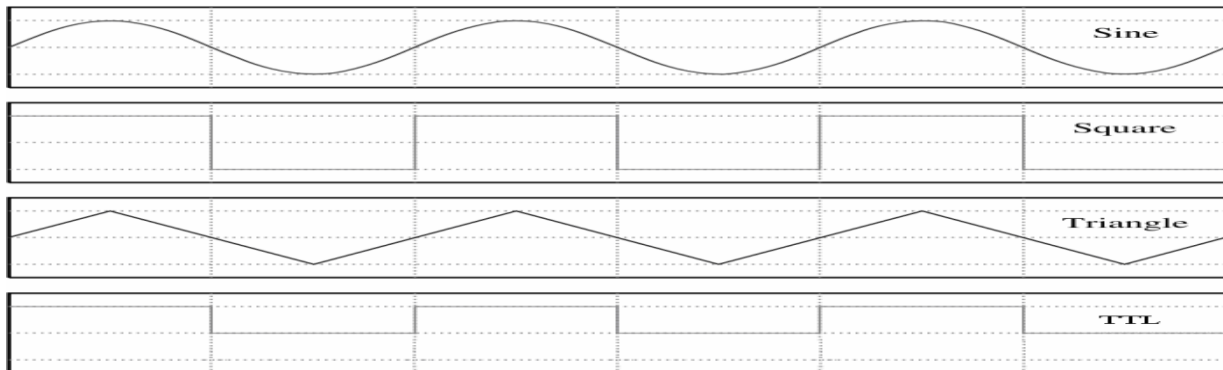

**Fig:8 Waveforms of function generator**

**Technical Specifications: -**

**Frequency Ranges: Selectable**

- a) 1 Hz to 10 Hz
- b) 10 Hz to 100 Hz
- c) 100 Hz to 1 KHz
- d) 1 KHz to 10 KHz

e) 10 KHz to 100 KHz

### **Amplitude Control Output**

Sine Wave : 6V  $V_{PP}$

Square Wave : 6V  $V_{PP}$

Triangular Wave : 6V  $V_{PP}$

TTL Output : 5V

**Duty Cycle** : Variable

**Sine Wave Generation** : By wave shaping circuit

**Switched Faults** : 4 Nos.

**Fuse** : 500 mA, slow blow

**Power Supply** : 230V $\pm$ 10%, 50 Hz

**Note:** Being a trainer it includes a lot of onboard test points which need the expansion of wires & tracks from the main circuit. Due to this a slight variation (10 to 15%) in frequency may be observed while we change duty cycle of signal.

### **QUIZ/ANSWERS:-**

Q1 What do you mean by CRO?

A1. Cathode Ray Oscilloscope.

Q2 Which component of CRO is termed as major or heart of CRO?

A2. CRT ( Cathode Ray Tube)

Q3 What are the major component of CRO?

A3. CRT, Vertical Amplifier, Delay line, Time base generator, Horizontal amplifier  
Trigger circuit, Power supply are the major component of CRO.

Q4 What is the need of sweep generator in CRO?

A4. To sweep the electron beam from left to right.

Q5 Name the material with which the screen is coated.

A5. Phosphor.

Q6 What is the function of function generator?

A6. To generate various waveforms like sine, square, triangular and pulse .

Q7 What is the name of coating for secondary electron absorption?

A7. Aquadag Coating

Q8 How many signals can be applied simultaneously to CRO?

A8. Two

Q9 What is the role of grid in CRO?

A9. To control the no. of electrons from cathode.

Q10 How is input applied to CRO?

A10. Through function generator.



more efficiently by Digital techniques than by Analog techniques. This has resulted in devices that are more advanced than available before. While most signals are analog in nature, the processing of signals is being performed by Digital techniques. All engineering disciplines now use digital techniques, which are almost indispensable in many fields. The parameters of interest in a laboratory environment are (1) Voltage (2) Current (3) Resistance(4) and Frequency (5).

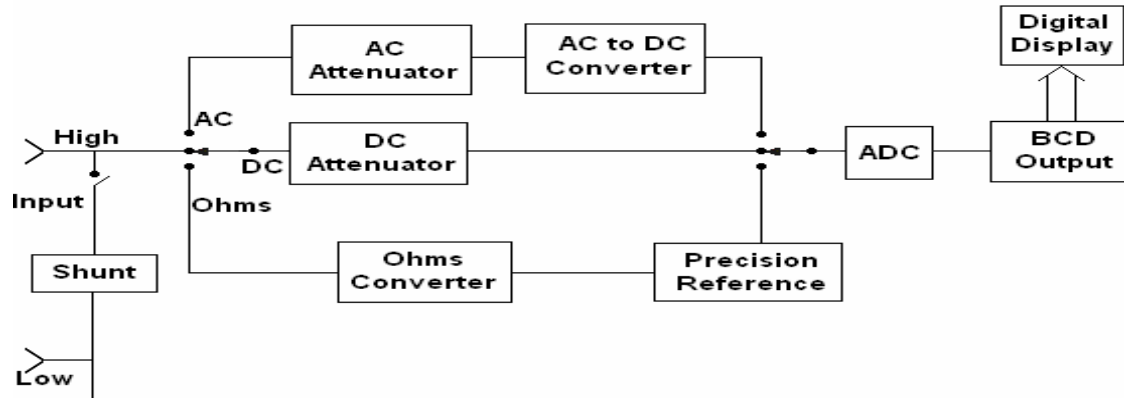

Fig:2 Block diagram of digital multimeter

## Digital Frequency Counter

**NV7105 Frequency Counter Trainer** consists of five blocks, namely, attenuator circuit, wave shaping circuit, frequency divider circuit, frequency counter, display driver circuit, and gate time circuit. All these circuits are incorporated on a single board for study/verification of attenuation, wave shaping, frequency division, and display driving mechanism. The board has inbuilt (SMPS) for DC power supply, so it can be taken as stand alone unit without any external power supply.

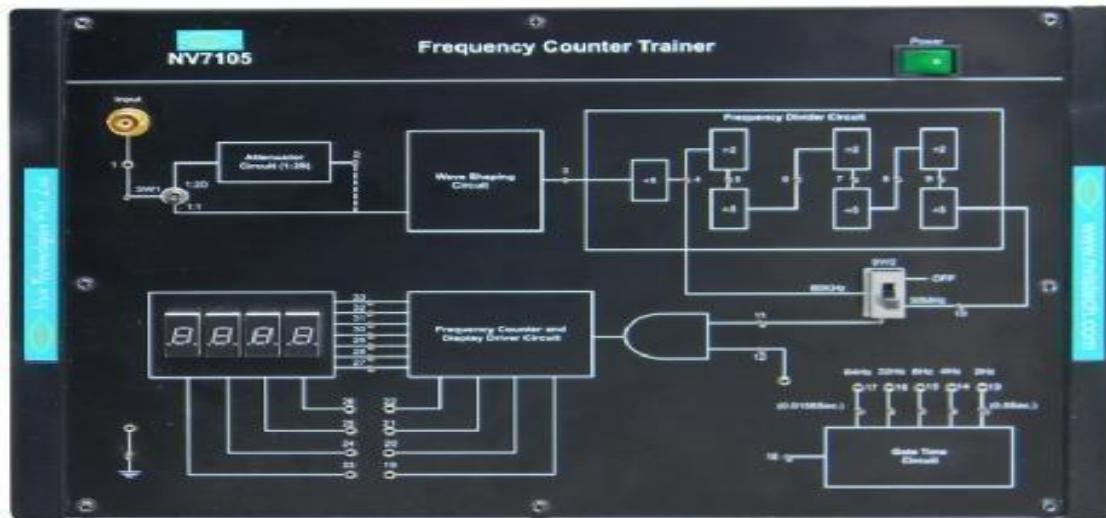
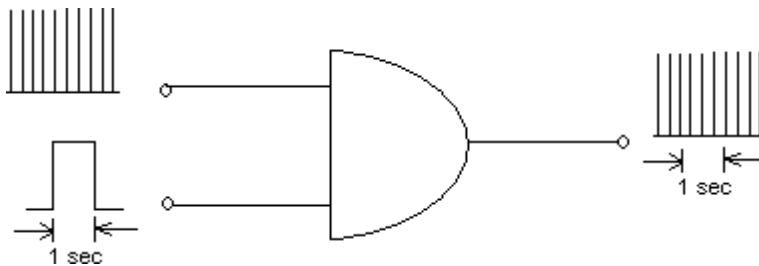

Fig:3 Frequency Counter Ckt. Diagram

The signal wave form is converted to trigger pulses and applied continuously to an AND gate, as shown in figure 1. A pulse of 1s is applied to the other terminal, and the number of pulses counted during this period indicates the frequency.



**Fig:4 Frequency Counter**

The signal whose frequency is to be measured is converted into a train of pulses; one pulse for each cycle of the signal. The number of pulses occurring in a definite interval of time is then counted by an electronic counter. Since each pulse represents the cycle of the unknown signal, the number of counts is a direct indication of the frequency of the signal (unknown). Since electronic counters have a high speed of operation, high frequency signal can be measured.

### **QUIZ/ ANSWERS:-**

Q.1 What is the function of a multimeter?

A.1 To measure voltage(AC or DC), current(AC or DC) and resistance.

Q.2 Write down the types of multimeter.

A.2 Analog and digital multimeter.

Q.3 What is the purpose of frequency counter?

A.3 By using frequency counter we can measure frequency,time period and time interval of any waveform.

Q.4 Which multimeter is advantageous ?

A.4 Digital multimeter.

Q.5 What is the accuracy of frequency counter?

## Electronic Measurement & Instrumentation (4EC4-24)

---

A.5 The accuracy of a frequency counter is strongly dependent on the stability of its timebase. Highly accurate circuits are used to generate this for instrumentation purposes, usually using a quartz crystal oscillator within a sealed temperature-controlled chamber known as a *crystal oven* or OCXO (oven controlled crystal oscillator).

Q.6 Why time period measurement is done in frequency meters ?

A.6 For achieving high accuracy in the case of low frequency measurement.

Q.7 What is the order of input impedance in digital instruments ?

A.7 Mega ohms

Q.8 What is the use of Schmitt trigger in digital frequency meter?

A.8 Converts sine wave into rectangular pulses.

Q.9 Why are multimeters provided with separate scale for low ac voltages?

A.9 To take into account the high value of resistance of rectifier at low voltages.

Q.10 For high value of resistance measurement is done by which instrument?

A.10 Meggar.

## EXPERIMENT No.3

**AIM:-** To study measurement of different components & parameters like Q of a coil etc. using LCR Q meter.

**APPARATUS REQUIRED:-** Caddo 9302 LCR meter.

### **THEORY:-**

Model **Caddo 9302** LCR meter is a micro desktop instrument by using microprocessor technology. It can measure six basic parameters i.e., inductance L, capacitance C, resistance R, impedance Z, dissipation factor D and quality factor Q, which can fulfill the measurement needs of various components manufacturers and maintenance technicians.

### **FRONT PANEL**

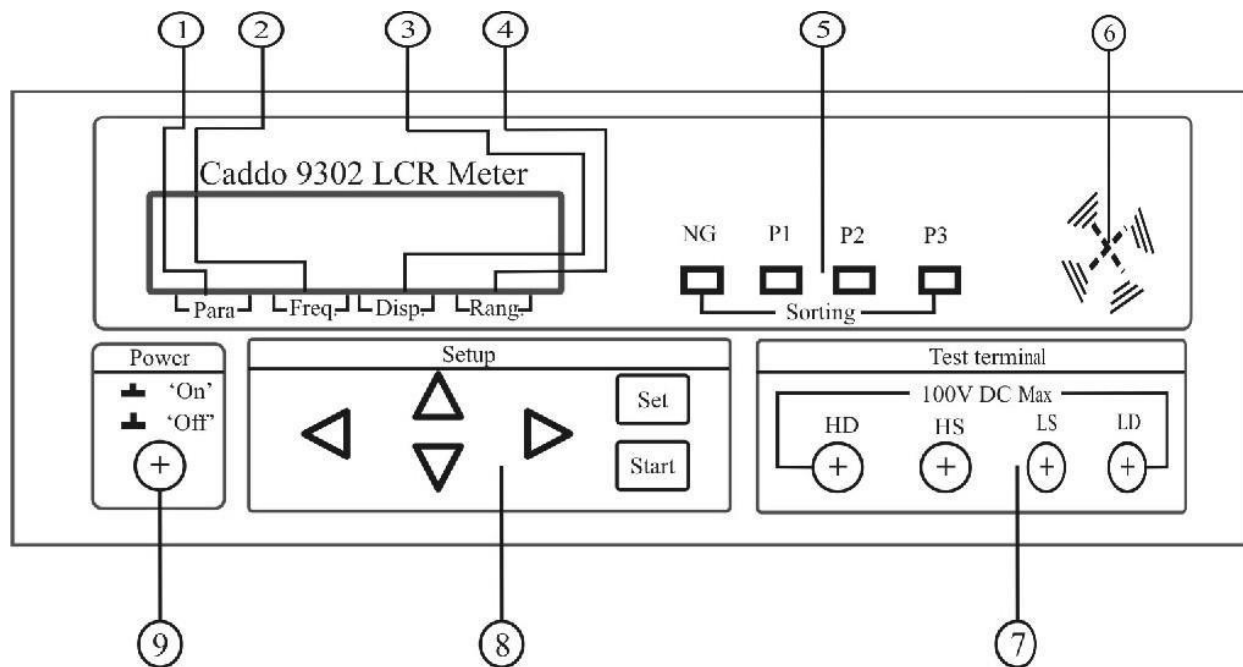

#### **1 Parameter**

Displaying current measured parameters:

L-Q, C-D, R-Q, Z-Q, Z-D or AUTO

#### **2 Frequency**

Displaying current frequency; 100 Hz, 120 Hz or

1 KHz

**3 DisplayMode** Displaying current display mode of the primary parameter: DIR %

**4 Range** Displaying range state: Auto, Hold or current range.

#### **5 Pins Indication**

NG: No-good; P1: Pass1; P2: Pass2; P3: Pass3;

P1, P2, P3 Priority is lower in turn.

### **6 Buzzer**

### **7 Test Terminals HD, HS, LS and LD**

Cursor keys Function table moving and rolling

Setup key Entering 8 Key function table setting

Start key The executing confirmation of command

### **9 Power** Power switch

## **Features**

### **1. Zero Correction :**

Open sweep correction of open circuit;

Short sweep correction of short circuit

### **2. Display Format :**

Direct actual measured value absolute delta between the measured value and the reference value; delta percent between the measured value and the reference value.

**3. Range Hold :** When measuring a large number of components with the same nominal value, this function can effectively improve the measuring speed.

**4. Comparator Function :** Caddo 9302s built-in comparator can sort components into a maximum of four bins (NG, P1, P2 and P3).

**5. Equivalent Measurement Circuit :** There are two equivalent circuit models: parallel and series.

## **OPERATION**

### **1 Direct function setup—— Parameter, frequency, display and range :**

a) Press keys to move the cursor and select one of the four direct functions.

b) Press keys to select.

**2** When measurement range is set to Auto, the instrument first estimates if current range is the correct range, if it's the correct range, then the instrument calculates and displays the measurement value, otherwise instrument has to change to the correct range and start measurement again. Therefore, in range Auto mode, one more measurement will be taken if the measurement range has to be changed. So more time is taken in range Auto mode.

**3** If a large number of devices under test belong to the same range, the correct range can be locked to raise the measurement speed. For the instrument do not have to take any time to find the correct the range.

**4** When measurement range is set to Hold, if the impedance under test exceeds the effective measuring range of the locked measurement range, overload symbols

**5.** How to calculate the measurement range

Example: Suppose capacitance  $C=210\text{pF}$ , dissipation  $D=0.0010$  and



test frequency  $f=1\text{KHz}$ .

Solution: We can calculate:  $Z_x = 757.9$

### **Indirect Functions Setup :**

Indirect functions are Clear "0", Sorting, Auto-LCZ, Buzzer, Change cursor, Advanced set, and State save & exit.

Press Setup key to enter the setup menu in measurement state. Pressing Setup key again, the instrument returns back to the measurement state.

### **PRECAUTIONS:-**

#### **Tuning On :**

**A.** Display company name and version the indicator lamps of P1, P2, P3, NG flash in turn.

**B.** Starting power-on self tests

**1.** EEPROM Memory checking

**2.** ADC AD converter checking

**C** Entering-measuring state after self-tests

The factory settings are listed as follows and can be reset according to the operation

**1.** Parameter: C-D;

**2.** Frequency: 100 Hz;

**3.** Display: Dir (direct reading);

**4.** Range: AUTO (automation);

**5.** Equivalent: SER (serial);

**6.** Alarm Bin: P1(Pass #1);

**7.** LCZ automation: Off;

**8.** Cursor

### **QUIZ/ ANSWERS:-**

Q.1 What do you mean by Q factor?

A.1 It is quality analysis of capacitor and inductor.

Q.2 What is the purpose of LCR Q meter?

A.2 It can measure 6 basic parameters, they are inductance L, capacitance C, resistance R, impedance Z, dissipation factor D and quality factor Q.

Q.3 What is the resonance condition?

A.3  $X_L = X_C$

Q.4 What is the formula of quality factor for inductor?

A.4  $Q = X_L / R$

Q.5 What is the range of shunt resistance in Q meter?

A.5 Miliohms

## Electronic Measurement & Instrumentation (4EC4-24)

---

Q.6 The Q factor of a coil at the resonant frequency 1.5 MHz of an RLC series circuit is 150. The bandwidth is ---- .

A.6 10 KHz

Q.7 What are the applications of Q-meter?

A.7 Measurement of Q, inductance, effective resistance, self capacitance, bandwidth and capacitance.

Q.8 What are the different methods of measurement of effective resistance?

A.8 1) resistance variation method

2) reactance variation method

Q.9 What is use of T-network?

A.9 T networks are very useful for measurement of inductance, capacitance, resistance and frequency in the high frequency range.

Q.10 What is the formula of distributed capacitance?

A.10  $C_d = C_1 - 4C_2/3$  (where  $C_1$  and  $C_2$  are tuning capacitors for resonant frequencies  $f_1$  and  $f_2$ ).

## EXPERIMENT No.4

**AIM:-** Study of distortion factor meter and determination of the % distortion of the given oscillator.

**APPARATUS REQUIRED:-** Caddo 4092 distortion Meter.

### **THEORY:-**

The **Caddo 4092** distortion Meter was developed for the measurement of non-linear distortion in the audio frequency range. Due to its low residual distortion and noise of 0.005% it is ideally suited for tests and measurements of high quality audio systems.

The **Caddo 4092** features an LCD Display readout with a resolution of 0.1 % to simplify and enhance distortion measurements. A calibrated distortion output is provided for visual inspection or spectral analysis of the input signal after the fundamental has been filtered out.

Together with pushbutton frequency range selectors and single control frequency tuning, the automatic frequency nulling with 20% capture range ensures quick and easy measurements with the **Caddo 4092**.

### **Features**

Frequency Range 20 Hz to 20 KHz

Distortion Measurement up to 0.1%

LCD Readout For Frequency and Distortion Measurement

Automatic Frequency Ranging & Nulling Facility

Output for Distortion Analysis

In built 50 MHz Frequency Counter

### **Front panel**

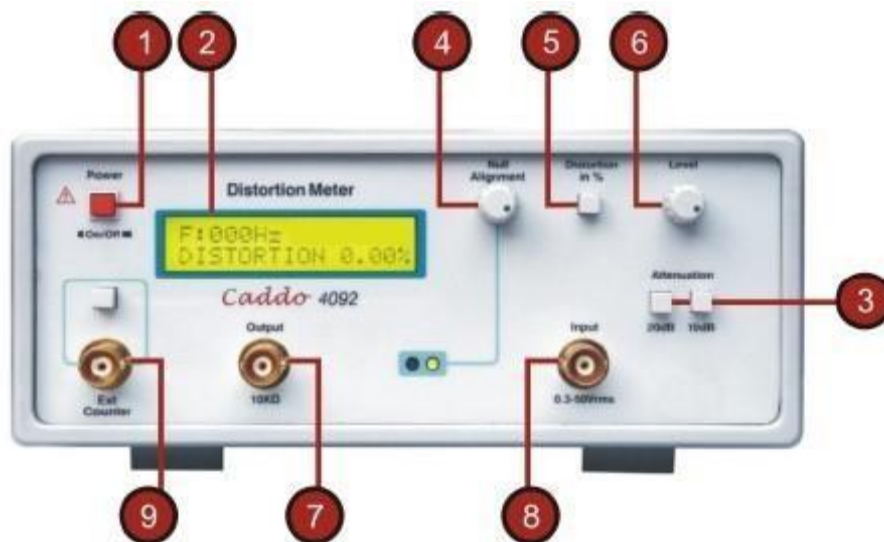

1) **Power:** Push button, selects instrument to switch 'On'

## Electronic Measurement & Instrumentation (4EC4-24)

---

- 2) **LCD Display:** LCD Readout for indication of the measured distortion factor in %.
- 3) **Attenuator (Pushbutton):** Input signal attenuation with two pushbutton switches of 20dB or 10dB attenuation, respectively. They can be used separately. Both push button switches activated, together with the variable attenuator (9) must enable a 100% reading when in the calibration mode; otherwise the input voltage should be adjusted.
- 4) **Tuning control with LED Indicator (LED):** If the built-in filter is incorrectly tuned, one of the two LEDs will indicate in which direction the filter frequency deviates from the input frequency. Turn tuning Knob (5) (N.A) in the opposite direction until the LED goes out.
- 5) **Level\Distortion (Pushbutton switch):** Adjustment for 100% reading with Level and then selection for 100% full scale.
- 6) **Level (Adjusting knob):** Continuous attenuation of input signal up to max. 50dB to achieve 100% reading when in the calibration mode.
- 7) **Output (BNC Connector):** Monitor output for distortion factor. (Residual distortion). Output voltage is 1mV/digit.
- 8) **Input (BNC Connector):** Input for measurement signal. The permissible input voltage range is 0.3V-50V for a valid measurement.
- 9) **External Counter:** It is the input for external signal whose frequency is to be measured.

### **PRECAUTION:-**

**Use proper Mains cord :** Use only the mains cord designed for this instrument. Ensure that the mains cord is suitable for your country.

**Ground the Instrument :** This instrument is grounded through the protective earth conductor of the mains cord. To avoid electric shock the grounding conductor must be connected to the earth ground. Before making connections to the input terminals, ensure that the instrument is properly grounded.

**Observe Terminal Ratings :** To avoid fire or shock hazards, observe all ratings and marks on the instrument.

**Use only the proper Fuse :** Use the fuse type and rating specified for this instrument.

**Use in proper Atmosphere :** Please refer to operating conditions given in the manual.

1. Do not operate in wet / damp conditions.
2. Do not operate in an explosive atmosphere.
3. Keep the product dust free, clean and dry.

### **QUIZ/ANSWERS:-**

Q.1 What is the use of distortion meter?

A.1 Distortion Meter for the measurement of non-linear distortion in the audio frequency range.

Q.2 Write down the types of distortion.

A.2 Frequency and Phase distortion.

Q.3 What is the meaning of IMD.

A.3 Intermodulation distortion, it is ratio of  $A_M$  to  $A_C$ .

Q.4 What are the types of distortion?

A.4(1)Frequency distortion( 2)Phase distortion(3)Amplitude distortion(4)intermodulation distortion(5)Cross-over distortion

Q.5 What is the reason of distortion?

A.5 Distortion is caused by many devices and components which form an electronic circuit.

Q.6 What is total harmonic distortion?

A.6 Total harmonic distortion is measured in terms of the harmonic content of the wave.

Q.7 Explain cross over distortion?

A.7 This type of distortion occurs in push pull amplifiers on account of incorrect bias levels.

Q.8 What is transient intermodulation distortion?

A.8 Transient intermodulation distortion occurs because an amplifier is not able to respond rapidly to changing inputs.

Q.9 Why frequency distortion occurs?

A.9 This type of distortion occurs because the amplification factor of the amplifier is different for different frequencies.

Q.10 Why harmonic distortion occurs?

A.10 Harmonic distortion occurs due to the fact that the amplifier generates harmonics of the fundamental of the input signal.

## EXPERIMENT No.5

**AIM:-** Measurement of displacement using LVDT.

**APPARATUS REQUIRED:-** LVDT kit, multimeter, connecting wires.

### **THEORY:-**

The differential transformer is a passive inductive transformer also known as Linear Variable Differential Transformer (LVDT). LVDT has a soft iron core which slides within the hollow transformer & therefore affects magnetic coupling between the primary and two secondaries. The displacement to be measured is applied at its arm attached to soft iron core. When core is in normal position (null), equal voltages are induced in the two secondaries. The frequency of ac applied to the primary winding ranges from 50Hz to 20KHz.

### **CIRCUIT DIAGRAM**

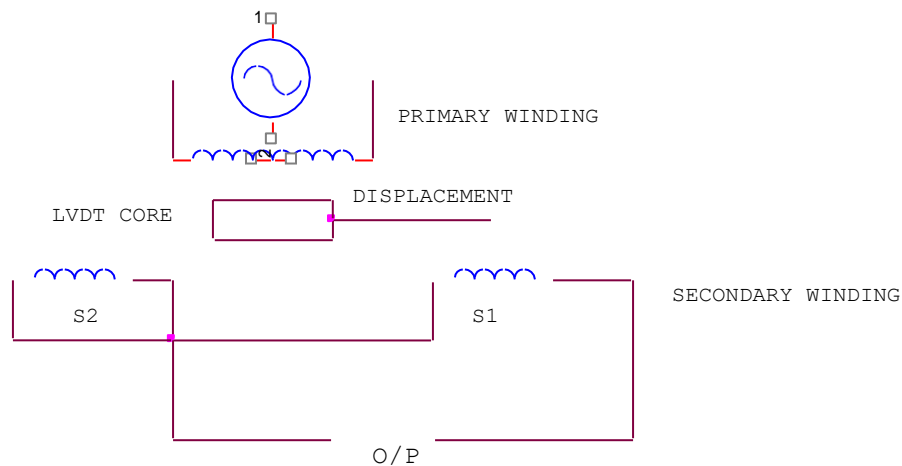

### **PROCEDURE:-**

1. Connect the circuit according to circuit diagram.
2. Switch on the power supply.
3. The core is initially brought to null position.
4. First turn the nut in clockwise direction to move core inwards i.e. left of null position & take respective voltage readings on the voltmeter.
5. Now turn nut in anticlockwise direction to move the core towards right of null point & again take respective voltage reading from voltmeter.
6. Plot the graph from the observations taken.

**OBSERVATIONS TABLE**

S.No.	Displacement Micrometer (mm)	Displacement Reading (mm)	Analog o/p

**GRAPH**

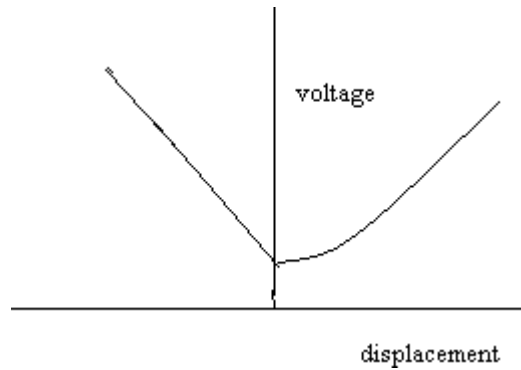

**RESULT: -** Graph between voltage and displacement is plotted.

### **PRECAUTIONS: -**

1. Handle all equipments with care.
2. Make connections according to the circuit diagram.
3. Take the readings carefully.
4. The connections should be tight.

### **QUIZ/ANSWERS:-**

Q1 What is LVDT?

A1 Linear Variable Differential Transformer.

Q2 Uses of LVDT

A2 Measurement of displacement, thickness measurement, level indicators

Q3 Core of LVDT is made up of which material?

A3 Soft iron

Q4 LVDT is active transducer or passive?

A4 Passive

Q5 what is the working principle of LVDT?

A5 Mutual Induction

Q6 Write any two advantages of LVDT.

A6 can tolerate vibrations and shocks, Good linearity

Q7 Any one disadvantage of LVDT.

A7 Affected due to stray magnetic fields.

Q8 How many secondaries are there in LVDT?

A8 Two

Q9 LVDT is which type of transducer?

A9 Inductive type

Q10 How do we take the output of LVDT?

A10 We take differential output of the two secondary.



## EXPERIMENT No.6

**AIM:-** Measurement of temperature using thermocouple, thermistor and RTD.

**APPARATUS REQUIRED:-** Thermocouple kit, Thermistor kit, RTD kit, heating arrangement, Ice, Thermometer, H<sub>2</sub>O.

**THEORY:-**

### THERMOCOUPLE

This transducer is widely used in industrial applications for temperature measurement. Thermocouple is active transducer because there is no need of voltage source and transducer bridge circuitry. The working principle of thermocouple is explained below: - When two dissimilar metals A & B are joined together to form a closed circuit and the junctions J<sub>1</sub> and J<sub>2</sub> are kept at two different temperatures T<sub>1</sub> and T<sub>2</sub> then an e.m.f. is generated resulting flow of current in the loop or circuit. The two junctions in the loop are reference or cold junction which is generally kept at 0°C and the other is hot junction at which the temperature is to be measured. The e.m.f. generated is proportional to the difference of temperatures, the materials used for thermocouple. This phenomenon is called as Seebeck effect. Thermocouple is having a lot of advantages like low cost, mechanically rigid and strong, high range etc. But the main disadvantage is that it requires a compensation arrangement.

### CIRCUIT DIAGRAM

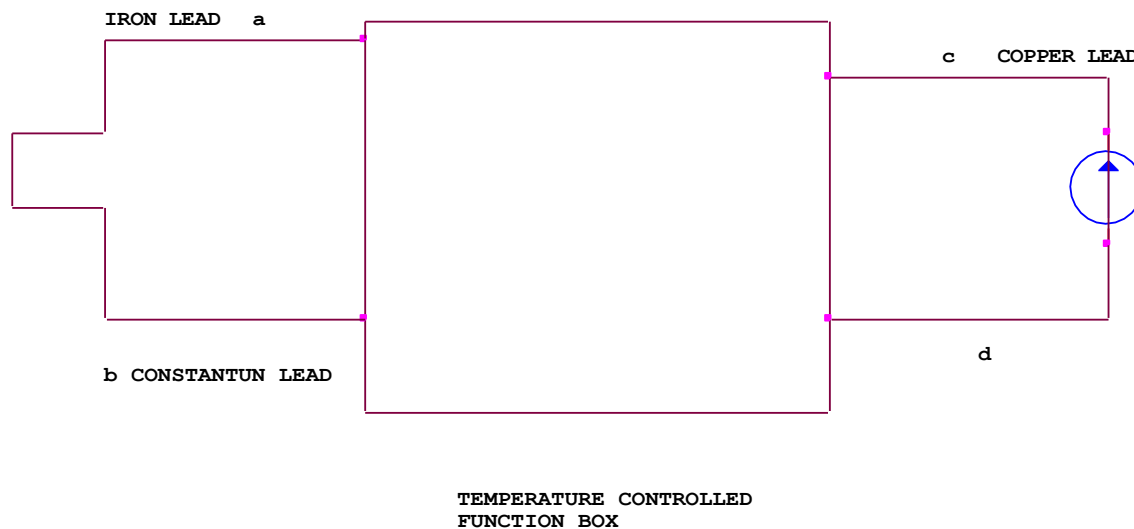

### THERMISTORS:

## Electronic Measurement & Instrumentation (4EC4-24)

Thermistors are also called thermal resistors. For thermistor the absolute temperature- resistance relationship is given by

$$R_T = R_{T_1} \exp [\beta(1/T_1 - 1/T_2)]$$

Where  $R_T$  = Resistance of the thermistor at absolute temperature  $T$   
 $R_{T_1}$  = Resistance of the thermistor at absolute temperature  $T_1$   
 $\beta$  = Constant  
 $T_1$  and  $T_2$  = Absolute temperatures

Thermistors are made up of semiconductor materials. As temperature changes the resistance of materials also changes. The temperature range for thermistor is  $-60^{\circ}\text{C}$  to  $+15^{\circ}\text{C}$ . Its resistance varies from  $0.5\Omega$  to  $0.75\text{M}\Omega$ . Thermistor is placed in contact with the media whose temperature is to be measured. As the temperature of the media changes, the resistance of the thermistor gets changed. This change of resistance can be measured by connecting the thermistor in any one arm of the Wheat stone bridge.

### CIRCUIT DIAGRAM

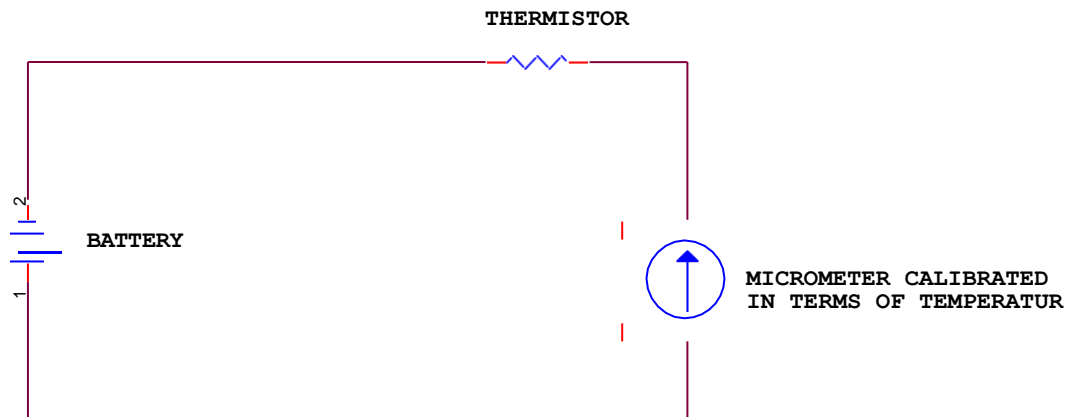

### RTD:

This type of transducer is used for temperature measurement. Here the basic concept used is that electrical resistance of different metal changes in accordance with the temperature i.e. for temperature measurement. Principle used is that the resistance of a conductor changes in proportion with the change in temperature. The unknown temperature is determined in terms of electrical resistance of the conductor, which senses the temperature. The change in resistance of this device is precisely determined either by bridge circuit or by ohmmeter. Resistance of a conductor changes with change in temperature. This property is used for the measurement of temperature and each transducer is called Resistive Thermometer and falls in the category of electrical resistive transducer. The variation of resistance 'R' with temperature 'T' can be presented as:

$$R=R_0(1+\alpha_1T+\alpha_2T^2+\dots)$$

Where  $R_0$  resistance at  $0^\circ\text{C}$

$\alpha_1, \alpha_2$  constant

Generally the metals used are Platinum. This is used because of following features:

1. Platinum provides good stability and accuracy.
2. It can operate on wide range of temperature.
3. It has good linearity over wide temperature range.
4. Less errors during operation.

## CIRCUIT DIAGRAM

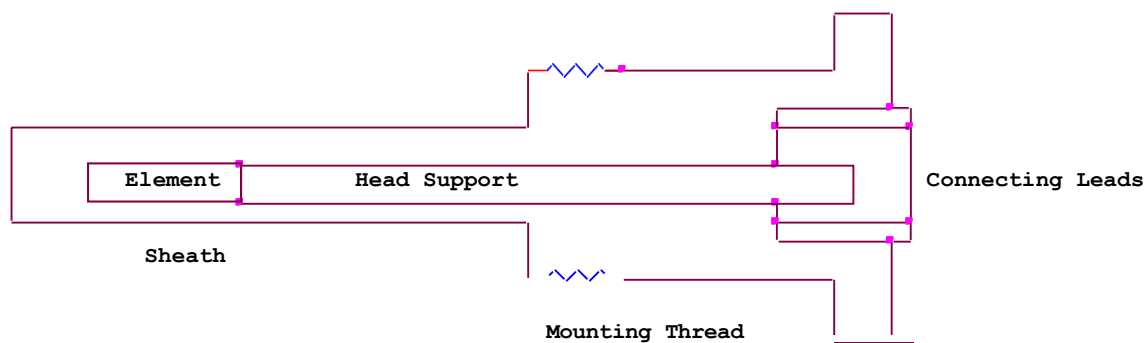

## PROCEDURE: -

### THERMOCOUPLE

1. Connect the main power cord at I/P main socket.
2. Switch ON the power supply
3. Connect the thermocouple sensor at the pin connector.
4. Keep the thermocouple in boiling water & adjust the display ranging 100 by the adjustment span knob.

### THERMISTOR

1. Connect the main power cord at I/P main socket.
2. Switch ON the power supply
3. Connect the thermistor sensor at the pin connector.
4. Keep the thermistor in boiling water & adjust the display ranging 100 by the adjustment span knob.

### RTD

## Electronic Measurement & Instrumentation (4EC4-24)

---

1. Connect the input power supply to main power.
2. Switch on the power supply, the red LED will glow.
3. Connect the RTD source/sensor at a pin connector & 100°C temperature is calibrated.

### OBSERVATION TABLE

S.No.	Temperature	Display Reading (mv) Thermocouple	Display Reading (mv) Thermistor	Display Reading (mv) RTD
	Temp with Ice point			
	Temp with Boiling Point			

**RESULT:** - We have measured the temperature using Thermocouple, Thermistor and RTD.

### **PRECAUTIONS:** -

5. Handle all equipments with care.
6. Make connections according to the circuit diagram.
7. Take the readings carefully.
8. The connections should be tight.

### **QUIZ / ANSWERS:** -

Q1 What is the working principle of thermocouple?

A1 When two dissimilar metals A & B are joined together to form a closed circuit and the junctions  $J_1$  and  $J_2$  are kept at two different temperatures  $T_1$  and  $T_2$  then an e.m.f. is generated resulting flow of current in the loop or circuit.

Q2 What are the types of thermocouple?

A2 J, K, E, T, S, R.

Q3 What is the cold junction compensation techniques?

- A3
1. Hardware compensation.
  2. Software compensation.

Q4 What are the advantages of thermistors?

A4 Small size, Compact, Good stability.

Q5 What are the limitations of thermistors?

A5 Non-linear, low temperature range, requires bridge arrangement.

Q6 What are the various configurations of thermistors?

A6 Bead, Probe, Disc and Rod.

Q7 What do you mean by RTD?

A7 Resistance Temperature Detector.

Q8 Which material is generally used in the construction of RTD?

A8 Platinum

Q9 What are the uses of RTD?

A9 Temperature measurement of solid, fluid and gases.

Q10 What are the applications of themocouples?

A10 They are extensively used in various automation systems for temperature measurements.

## EXPERIMENT No.7

**AIM:-** Measurement of strain using strain gauge.

**APPARATUS REQUIRED:-** Strain cantilever kit, multimeter, connecting wires.

### **THEORY:-**

Strain is defined as compression per unit area. The primary quantities like resistance, capacitance are measured with the strain gauge element, where force applied to any elastic material, results in strain.

$$R = \rho L / A$$

Where R= resistance ( $\Omega$ )

$\rho$ = Resistivity ( $\Omega\text{-m}$ )

L= Length of wire (m)

A= Uniform cross- sectional area of wire ( $\text{m}^2$ )

If a metal wire or conductor is stretched or compressed its resistance changes because of change in length, change in resistivity and change in cross sectional area. This effect is called piezoresistive effect. The cantilever used in the primary elastic transducer of force measuring system, where a known mass is attached to cantilever, the unbalanced voltage, can be calibrated in terms of either force or weight.

### **CIRCUIT DIAGRAM**

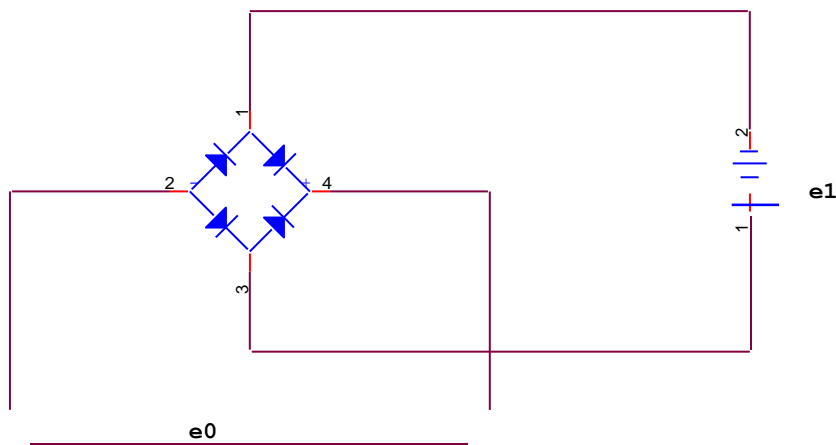

### **PROCEDURE:-**

1. Connect the strain cantilever at the experimental kit.

## Electronic Measurement & Instrumentation (4EC4-24)

---

2. Switch ON the power supply.
3. Give some time to stabilize the instrument.
4. Balance the strain cantilever bridge by corresponding zero, then turn trim port.
5. Set the gain of strain cantilever by SPAN, then turn trim port.
6. Now apply weight at the cantilever beam and take readings.

### OBSERVATION TABLE

S.No.	Weight	Display Reading	Analog O/P (volt)	Signal (mV)

### SAMPLE CALCULATION

$$R = \rho L / A$$

Where R= resistance ( $\Omega$ )

$\rho$ = Resistivity ( $\Omega$ -m)

L= Length of wire (m)

A= Uniform cross- sectional area of wire ( $m^2$ )

**RESULT:** - Weight can be measured by using strain gauge

### **PRECAUTIONS:** -

9. Handle all equipments with care.
10. Make connections according to the circuit diagram.
11. Take the readings carefully.
12. The connections should be tight.

### **QUIZ / ANSWERS :-**

Q1 What is the working principle of strain gauge?

A1 Piezoresistive effect

## Electronic Measurement & Instrumentation (4EC4-24)

---

Q2 Which type of transducer is strain gauge?

A2 Resistive

Q3 What are the advantages of strain gauges?

A3 High gauge factor and excellent hysteresis characteristics

Q4 What are the uses of strain gauges?

A4 Measurement of force & pressure, displacement, acceleration etc

Q5 What do we call the combination of gauges?

A5 Rosettes

Q6 Is it active type of transducer or of passive type?

A6 passive

Q7 How would you classify strain gauge?

A7 Bonded wire, Bonded metal, Semiconductor type etc

Q8 What is strain?

A8 Strain is defined as compression per unit area.

Q9 What is gauge factor?

A9 Gauge factor is defined as the ration of per unit change in resistance to per unit change in length.

Q10 What is Poisson's ratio?

A10 Poisson's ratio,  $\gamma = -(\partial D/D)/(\partial L/L)$



## EXPERIMENT No. 8

**AIM:-** Study of Differential Pressure Transducer & signal conditioning of output signal.

**APPARATUS REQUIRED:-** ST2308 Pressure Transducer Trainer, Pressure Vessel, Foot Pump, Connecting Tube (1.5 meters)

### **THEORY:-**

Differential pressure = the difference between two referenced pressures. So gauge pressure is a sort of differential pressure where one of the referenced pressures is atmospheric pressure. All pressure measurements are differential. The reference can be zero absolute pressure, atmospheric pressure (the barometric pressure), or another pressure.

### **Circuit Diagram:**

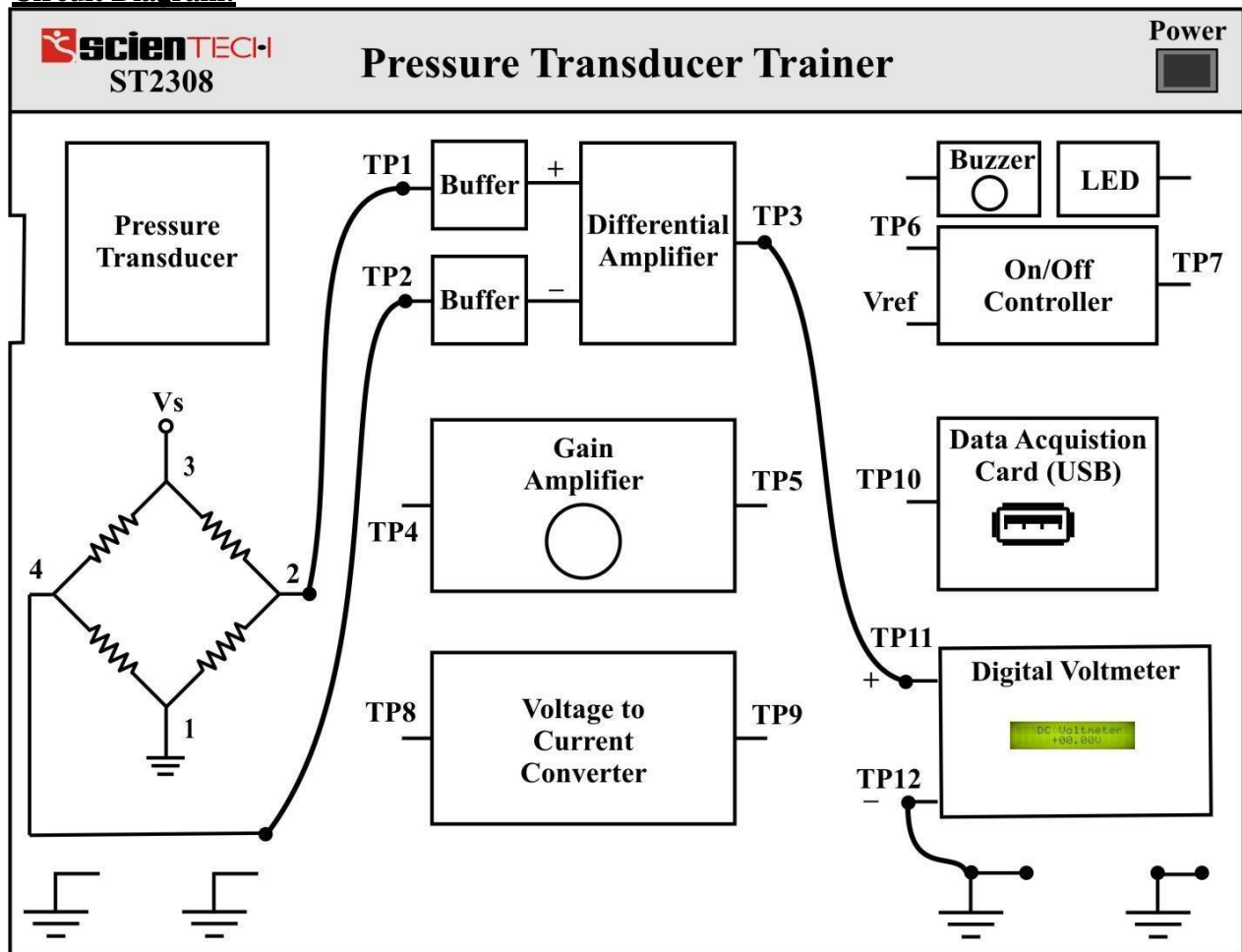

### **PROCEDURE:**

1. Fill the pressure vessel up to 90 psi (don't cross the range) with the help of foot

## Electronic Measurement & Instrumentation (4EC4-24)

---

pump, while filling be sure that the outlet valve is closed (Off Position).

2. Connect the outlet (valve with lever) of the Pressure Vessel to any one of the inlet (either P1 or, P2) of the Pressure Transducer with the help of tube provided.

3. Keep the other inlet (P1 or, P2) of the Transducer, so that the other pressure will be the Atmospheric pressure.

4. Connect the circuit as shown in the *figure* .

**5. Switch on the power of ST2308 Pressure Transducer Trainer**

6. Now, very slowly open the valve in order to release the pressure from the vessel and flow to the transducer's input.

7. Observe the DVM and Pressure Gauge, and note down the readings in observation table.

8. Plot the Graph according to the readings

### **OBSERVATION:**

Sr. No.	DVM Voltage (volts)	Pressure Gauge (psi)
1.		
2.		
3.		
4.		
5.		
6.		
7.		
8.		
9.		

**Plot the graph between pressure vs voltage**

### **PRECAUTIONS:**

1. Use the trainer kit with care.
2. To avoid fire or shock hazards, observe all ratings and marks on the instrument.
3. Do not operate in wet / damp conditions
4. Use the fuse type and rating specified for this instrument.

### **QUIZ / ANSWERS:-**

Q1 What is differential pressure?

A1 When absolute pressure is measured with respect to some reference pressure.

Q2 Which is the general reference pressure used?

A2 Atmospheric pressure.

## Electronic Measurement & Instrumentation (4EC4-24)

---

Q3 What is pressure?

A3 It is defined as the force per unit area.

Q4 Describe the working principle of differential pressure transducer.

A4 When different pressures are applied at two points of force collecting arrangement such as resistive strain gauge, resistance at the pressurised point changes and hence voltage unbalancing occurs.

Q5 Give some examples of applications of DPT?

A5 It finds application in flow measurement, fluid pressure measurement, orifice flow measurement etc.

Q6 Which states of matter generally allow pressure measurement?

A6 Liquids and gases.

Q7 What is signal conditioning?

A7 When the output from the transducer is modified such as to bring it to presentable level, it is called signal conditioning.

Q8 Give some units of pressure.

A8 psi, atm, torr, pascal, mm Hg etc.

Q9 What is strain?

A9 Strain is defined as compression per unit area

Q10. Give examples of active and passive transducers.

A10: Active transducer: Solar cell, Piezo Electric crystal, Thermocouple

Passive transducer: LDR, Photo diode, RTD

## EXPERIMENT No.9

**AIM:-** Study of water level measurement using capacitive transducer.

**APPARATUS REQUIRED:-** ST2309 with power supply cord, Water Level Sensor, Measuring Tank, Ammeter, 2mm Patch Cords (5Nos).

**THEORY:** -

### Capacitive Pressure Transducer:

Capacitance pressure transducers were originally developed for use in low vacuum research. This capacitance change results from the movement of a diaphragm element. The diaphragm is usually metal or metal-coated quartz and is exposed to the process pressure on one side and to the reference pressure on the other principle of “Strain Gauge” i.e when any pressure (force) is exerted on the strain gauge, there is corresponding change in its resistance. This change in resistance will produce an electrical output in the range of millivolts that is proportional to the applied pressure. Depending on the type of pressure, the capacitive transducer can either be an absolute, gauge.

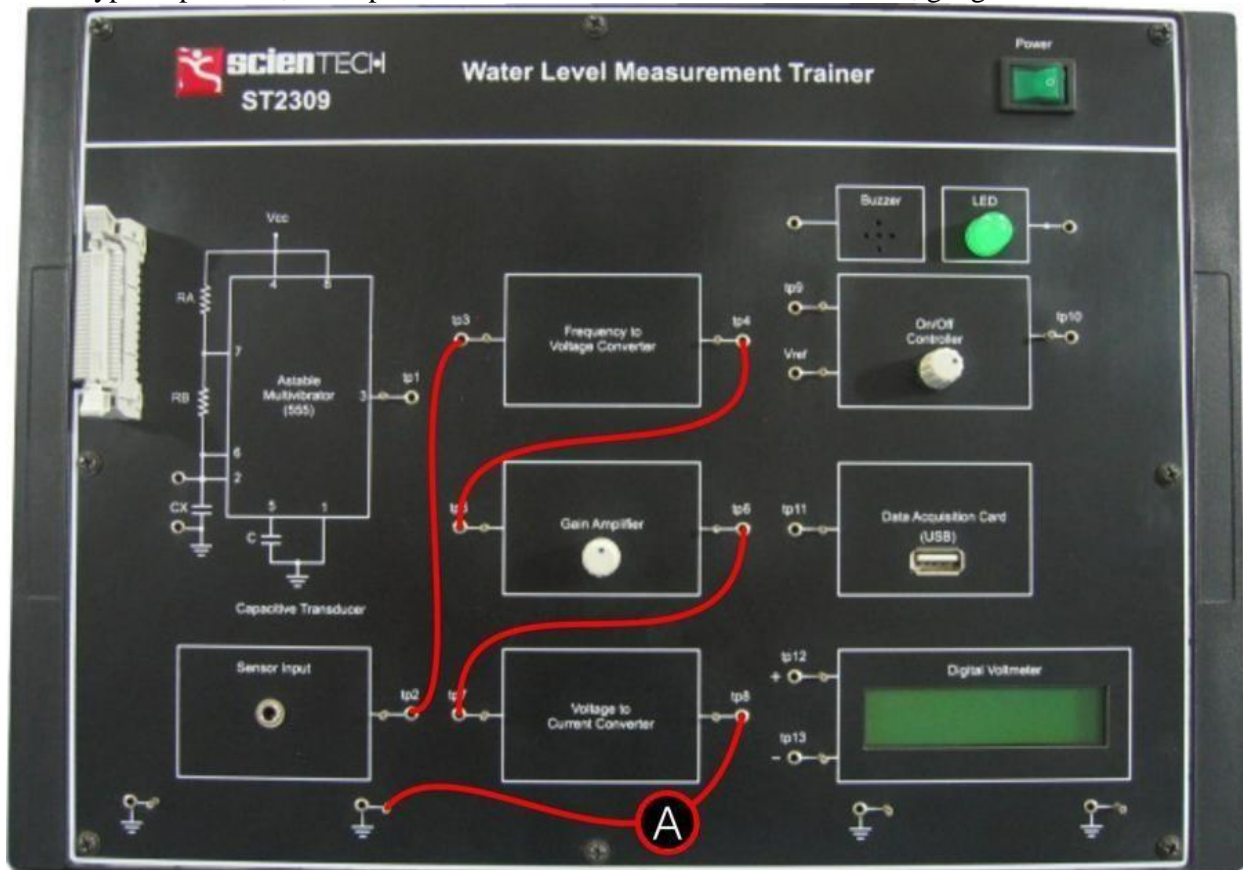

### **PROCEDURE :**

1. Connect a Water Level sensor across the Sensor Input provided on the Trainer.

## Electronic Measurement & Instrumentation (4EC4-24)

---

2. Make the connection in the trainer as shown in the *figure* .
3. Connect the output of Voltage to Current Converter to the positive terminal of an Ammeter.
4. Ground the negative terminal of the Ammeter.
5. Switch 'On' the power supply.
6. Gradually add water to the Measuring Tank.
7. Note the change in Current after every 100ml rise in water level in the measuring tank.
8. Note the Current Readings and corresponding Water Level change in the observation table.
9. Shift the Gain amplifier to least, middle & maximum position & repeat the above Procedure to get different readings.
10. Sketch a graph between voltage & water Level.

### **OBSERVATION TABLE**

Sr. No.	Water Level (ml)	Voltage (Volts)
1.		
2.		
3.		
4.		
5.		
6.		

### **PRECAUTIONS:-**

1. Use the trainer kit with care.
2. To avoid fire or shock hazards, observe all ratings and marks on the instrument.
3. Do not operate in wet / damp conditions.
4. Use the fuse type and rating specified for this instrument.

### **QUIZ/ANSWERS:-**

Q1. What is capacitor?

A1 A capacitor is a small device that can be charged up with electrical energy, store it and then release it.

Q2 What do you understand by transducer and inverse transducers?

A2: Transducers can be broadly defined as a device which converts a non electrical quantity into an electrical quantity. An inverse transducer is a device which converts an electrical quantity into a non electrical quantity.

Q3 What is the construction of capacitor?

## Electronic Measurement & Instrumentation (4EC4-24)

---

A3 A capacitor is made from two metal plates or metal foils separated by an insulator called a Dielectric material. The Dielectric materials can be made from Ceramic, Mica, Polypropylene, Polyester, Electrolytic, Tantalum and even air.

Q4 What are the Characteristics of Transducer?

A4 When choosing a transducer for any application, the input, transfer & output characteristics have to be taken into account.

Q5 Give examples of transducer and inverse transducers?

A5 Transducer: Microphone  
Inverse Transducer: Loud speaker

Q6. What do you understand by primary and secondary transducers?

A6 A primary transducer is one which responds to physical phenomenon or a change in physical phenomenon. The response of primary transducer must be closely related to the physical phenomenon. A secondary transducer is one which transforms the output of the primary transducer to an electrical output.

Q7 Give examples of primary and secondary transducers?

A7 Primary Transducers: LDR, Photo diode, RTD  
Secondary Transducer: Wheat Stone Bridge, LVDT

Q8 What is the function of 555 timers?

A8 The **555 Timer** is a very cheap, popular and useful precision timing device that can act as either a simple timer to generate single pulses or long time delays, or as a relaxation oscillator producing stabilized waveforms of varying duty cycles from 50 to 100%.

Q9 Explain the constructional details of 555 timer?

A9 The single 555 Timer chip in its basic form is a Bipolar 8-pin mini Dualin-line Package (DIP) device consisting of some 25 transistors, 2 diodes and about 16 resistors arranged to form two comparators, a flip-flop and a high current output stage.

Q10 Write the application of 555 timer?

A10 The 555 timer chip is extremely robust and stable 8-pin device that can be operated either as a very accurate **Monostable**, **Bistable** or **Astable** multi vibrator to produce a variety of applications such as one-shot or delay timers, pulse generation, LED and lamp flashers, alarms and tone generation, logic clocks, frequency division, power supplies and converters etc.

## EXPERIMENT No.10

**AIM:-** Study of Distance measurement using Ultrasonic Transducer.

**APPARATUS REQUIRED:-** ST2312 trainer with power supply cord, 2mm Patch Cords (8 pieces) and Power Cord

**THEORY:-**

Ultrasonic is defined as that band above 20 KHz. It continues up into the MHz range and finally, at around 1 GHz. Ultrasonic sensors (also known as transducers when they both send and receive) work on a principle similar to radar or sonar which evaluate attributes of a target by interpreting the echoes from radio or sound waves respectively. Ultrasonic sensors generate high frequency sound waves and evaluate the echo which is received back by the sensor. Sensors calculate the time interval between sending the signal and receiving the echo to determine the distance to an object. Ultrasonic sensors are active, visible, volumetric sensors.

**PROCEDURE:**

1. Connect the mains chord to Trainer.
2. Make the Connection in the trainer as shown in *figure*.
3. Switch 'On' the Power Supply.
4. Keep the toggle switch at '1' position as shown in *figure*.
5. Connect a voltmeter as shown in the *figure*.
6. Adjust the knob of Threshold Detector so the voltmeter reading becomes 4 V.
7. Move any flat object up and down the ultrasonic sensors. Make sure that the object is parallel to the trainer.
8. Observe the seven segment display as it shows the distance (in meters) between the ultrasonic sensors and the object.

**OBSERVATION**

The output is observed on seven segment display.

**PRECAUTIONS:**

1. Use the trainer kit with care.
2. To avoid fire or shock hazards, observe all ratings and marks on the instrument.
3. Do not operate in wet / damp conditions.

### **QUIZ/ANSWERS:-**

Q1 What is the difference between sensor and transducer?

A1 The sensor senses the condition, state or value of the process variable and produces an output which reflects this condition, state or value. The transducer transforms the energy of the process variable to an output of some other energy which is able to operate some control device.

Q2 What are the features of ultra sonic waves?

A2 There are two unique features of ultrasonic waves:

- Ultrasonic waves travel slowly, about 100,000 times slower than electromagnetic waves. This provides a way to display information in time, create variable delay, etc.
- Ultrasonic waves can easily penetrate opaque materials, whereas many other types of radiation such as visible light cannot. Since ultrasonic wave sources are inexpensive, sensitive, and reliable, this provides a highly desirable way to probe and image the interior of opaque object.

Q3 What is ultra sonic transducer?

A3 An ultrasonic transducer is a device that converts energy into ultrasound, or sound waves above the normal range of human hearing.

Q4 What is the function of ultra sonic sensors?

A4 Ultrasonic sensors generate high frequency sound waves and evaluate the echo which is received back by the sensor. Sensors calculate the time interval between sending the signal and receiving the echo to determine the distance to an object.

Q5 What is the frequency range of ultra sonic waves?

A5 They establish a detection field using energy in the acoustic spectrum typically in the frequency range between 19 and 40 KHz.

Q6 How ultra sonic transducer works?

A6 Ultrasonic range sensor works by emitting a short burst of 40 KHz ultrasonic sound from a piezoelectric transducer. A small amount of sound energy is reflected by objects in front of the device and returned to the detector, another piezoelectric transducer. The receiver amplifier sends these reflected signals (echoes) to microcontroller which times them to determine how far away the objects are, by using the speed of sound in air. The calculated range is then displayed on the screen.

Q7 What are the advantages of ultrasonic signals?

A7 The advantages of ultrasonic signals are:

- Long range detection
- Broad area detection
- Widest range of target materials
- Non contact distance measuring
- Unaffected by atmospheric conditions



## Electronic Measurement & Instrumentation (4EC4-24)

---

Q8 What are the Characteristics of Transducer?

A8 When choosing a transducer for any application, the input, transfer & output characteristics have to be taken into account.

Q9 What are the conditions are considered for Output Characteristics?

A9 The three conditions in the output characteristics which should be considered:

- a. Type of electrical output,
- b. Output Impedance,
- c. Useful Range.

Q10. Give examples of active and passive transducers?

A10. Active transducer: Solar cell, Piezo Electric crystal, Thermocouple  
Passive transducer: LDR, Photo diode, RTD